











# Table of Contents

<b>Table of Contents</b> .....	<b>1</b>
<b>Usage Notice</b> .....	<b>2</b>
<i>Precautions</i> .....	2
<b>Introduction</b> .....	<b>4</b>
<i>Product Features</i> .....	4
<i>Package Overview</i> .....	5
<i>Product Overview</i> .....	6
<i>Main Unit</i> .....	6
<i>Control Panel</i> .....	7
<i>Connection Ports</i> .....	8
<i>Remote Control with Mouse Function &amp; Laser Pointer</i> .....	9
<b>Installation</b> .....	<b>10</b>
<i>Connecting the Projector</i> .....	10
<i>Powering On/Off the Projector</i> .....	11
<i>Powering On the Projector</i> .....	11
<i>Powering Off the projector</i> .....	12
<i>Warning Indicator</i> .....	12
<i>Adjusting the Projected Image</i> .....	13
<i>Adjusting the Projector Image Height</i> .....	13
<i>Adjusting the Projector Zoom / Focus</i> .....	14
<i>Adjusting Projected Image Size</i> .....	14
<b>User Controls</b> .....	<b>15</b>
<i>Control Panel &amp; Remote Control</i> .....	15
<i>On-Screen Display Menus</i> .....	18
<i>How to operate</i> .....	18
<i>Language</i> .....	19
<i>Image-I (Computer Mode)</i> .....	20
<i>Image-I (Video Mode)</i> .....	21
<i>Image-II</i> .....	22
<i>Audio</i> .....	24
<i>Management</i> .....	25
<i>PIP</i> .....	27
<b>Appendices</b> .....	<b>28</b>
<i>Troubleshooting</i> .....	28
<i>Replacing the lamp</i> .....	32
<i>Compatibility Modes</i> .....	33
<i>Ceiling Mount Installation</i> .....	34

# Usage Notice

## Precautions

*Follow all warnings, precautions and maintenance as recommended in this user's guide to maximize the life of your unit.*

-  **Warning-** Do not look into the projector's lens when the lamp is on. The bright light may hurt your eyes.
-  **Warning-** To reduce the risk of fire or electric shock, do not expose this product to rain or moisture.
-  **Warning-** Please do not open or disassemble the product as this may cause electric shock.
-  **Warning-** When changing the lamp, please allow unit to cool down, and follow all changing instructions.
-  **Warning-** This product will detect the life of the lamp itself. Please be sure to change the lamp when it shows warning messages.
-  **Warning-** Reset the "Lamp Reset" function from the On Screen Display "Management-->Lamp" menu after replacing the lamp module (refer to page 26).
-  **Warning-** When switching the projector off, please ensure the projector completes its cooling cycle before disconnecting power.
-  **Warning-** Turn on the projector first and then the signal sources.
-  **Warning-** Do not use lens cap when projector is in operation.
-  **Warning-** When the lamp reaches the end of its life, it will burn out and may make a loud popping sound. If this happens, the projector will not turn back on until the lamp module has been replaced. To replace the lamp, follow the procedures listed under "Replacing the Lamp".

# Usage Notice

## ***Do:***

- ❖ Turn off the product before cleaning.
- ❖ Use a soft cloth moistened with mild detergent to clean the display housing.
- ❖ Disconnect the power plug from AC outlet if the product is not being used for a long period of time.

## ***Don't:***

- ❖ Block the slots and openings on the unit provided for ventilation.
- ❖ Use abrasive cleaners, waxes or solvents to clean the unit.
- ❖ Use under the following conditions:
  - In extremely hot, cold or humid environments.
  - In areas susceptible to excessive dust and dirt.
  - Near any appliance that generates a strong magnetic field.
  - Place in direct sunlight.

# Introduction

## Product Features

*This product is an XGA single chip 0.7" DLP™ projector. Outstanding features include:*

- ◆ True XGA, 1024 x 768 addressable pixels
- ◆ Single chip DLP™ technology
- ◆ NTSC/NTSC4.43/PAL/PAL-M/PAL-N/SECAM and HDTV compatible (480i/p, 576i/p, 720p, 1080i)
- ◆ HDCP compliant
- ◆ High-tech DVI-I connection for digital and analog video connectivity
- ◆ Full function remote with mouse control and laser pointer
- ◆ User friendly multilingual on screen display menu
- ◆ Advanced **digital** keystone correction and high quality full screen image re-scaling
- ◆ User friendly control panel
- ◆ **Picture-In-Picture dual image**
- ◆ UXGA, SXGA compression and VGA, SVGA re-sizing
- ◆ Mac compatible

# Introduction

## Package Overview

*This projector comes with all the items shown below. Check to make sure your unit is complete. Contact your dealer immediately if anything is missing.*Option



Projector with lens cap



Power Cord 1.8m



VGA Cable 1.8m



Composite Video Cable  
1.8m



DVI to D-Sub Cable  
1.8m



RCA Component Cable for YPbPr  
1.8m



S-Video Cable 1.8m



Remote Control with  
Mouse Function & Laser  
Pointer



2 x Battery

### Documents :

- User's Guide
- Quick Start Card
- Warranty Card



Optional Case

# Introduction

## Product Overview

### Main Unit

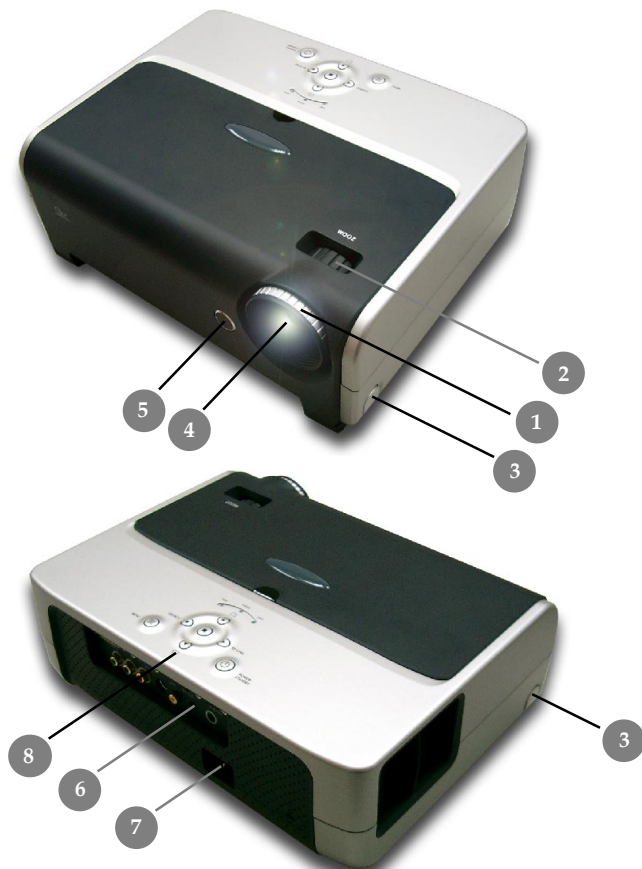

1. Focus Ring
2. Zoom Ring
3. Elevator Button
4. Zoom Lens
5. Remote Control Receiver
6. Connection Ports
7. Power Socket
8. Control Panel

# Introduction

## Control Panel

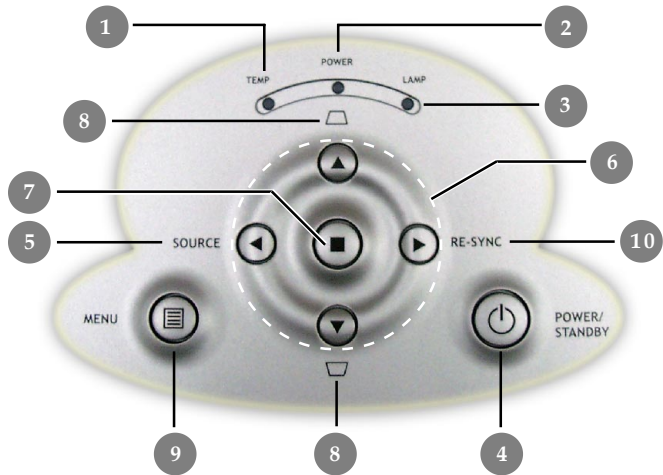

1. Temp Indicator LED
2. Power Indicator LED
3. Lamp Indicator LED
4. Power/Standby
5. Source
6. Four Directional Select Keys
7. Enter
8. Keystone Correction
9. Menu (On/Off)
10. Re-sync

# Introduction

## Connection Ports

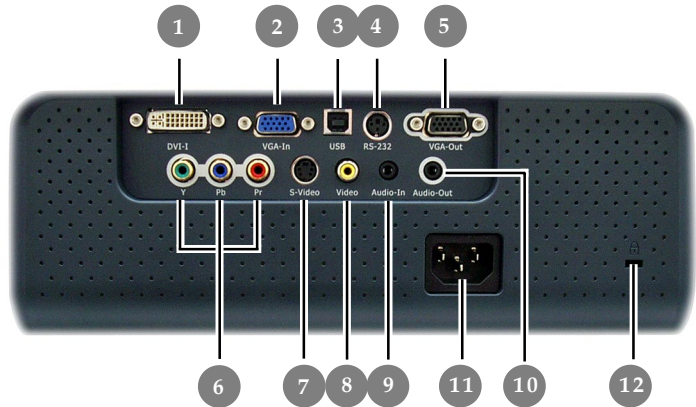

1. DVI-I Input Connector (PC Digital and Analog signal/HDTV/HDCP/Component Video Input )
2. VGA Connector (PC Analog Signal/HDTV/Component Video Input)
3. USB Input Connector
4. RS232 Input Connector
5. Monitor Loop-through Output Connector
6. Component Video Input Connector
7. S-Video Input Connector
8. Composite Video Input Connector
9. Audio Input Connector
10. Audio Output Connector
11. Power Socket
12. Kensington™ Lock Port



# Introduction

## Remote Control with Mouse Function & Laser Pointer

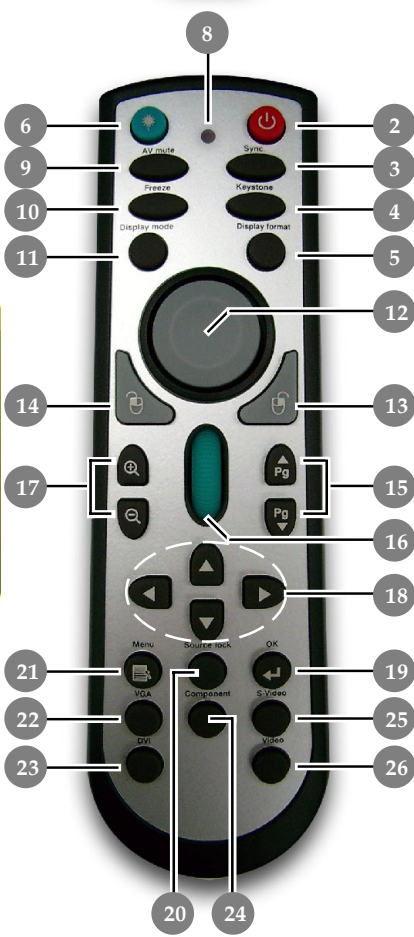

1. IR LEDs
2. Power
3. Sync
4. Keystone Correction
5. Display Format
6. Laser Button
7. Laser Pointer
8. Laser Indicator LED
9. A/V Mute
10. Freeze
11. Display Mode
12. Mouse
13. Mouse Right Click
14. Mouse Left Click
15. Page Up / Page Down
16. Page Scrolling
17. Zoom In/Zoom Out
18. Four Directional Select Keys
19. OK (Enter)
20. Source Lock
21. Menu
22. VGA Source
23. DVI-I Source
24. Component Video Source
25. S-Video Source
26. Composite Video Source



# Installation

## Connecting the Projector

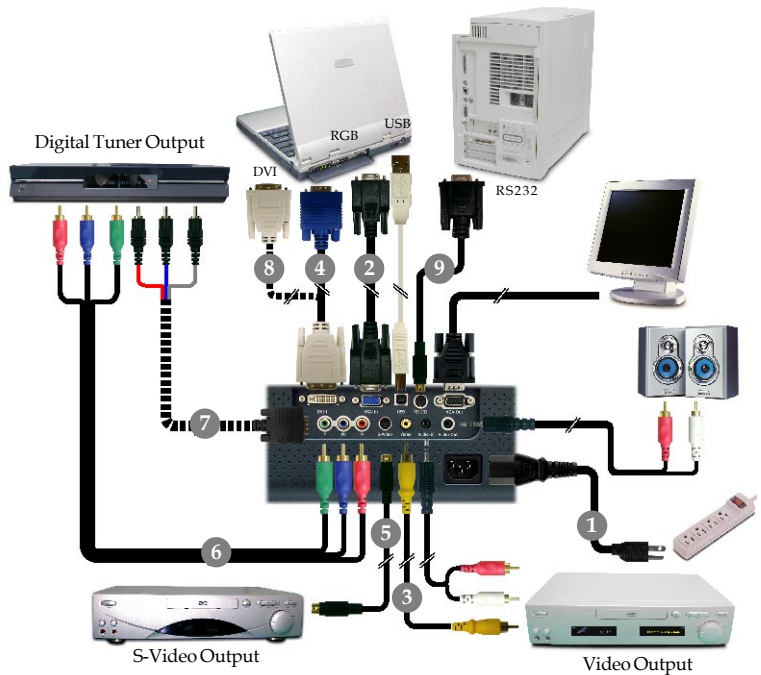

- 1..... Power Cord
- 2..... VGA Cable
- 3..... Composite Video Cable
- 4..... DVI to D-Sub Cable
- 5..... S-Video Cable
- 6..... RCA Component Cable for YPbPr
- 7..... D-Sub to RCA Cable for HDTV/Component (Optional Accessory)
- 8..... DVI to DVI Cable (Optional Accessory)
- 9..... RS232 Cable (Optional Accessory)

❖ *To ensure the projector works well with your computer, please set the display mode of your graphic card less than or equal to 1024 X 768 resolution. Make sure the timing of the display mode is compatible with the projector. Refer to the "Compatibility Modes" section on page 33.*

# Installation

## Powering On/Off the Projector

### Powering On the Projector

1. Remove the lens cap.
2. Ensure that the power cord and signal cable are securely connected. The Power LED will turn **red**.
3. Turn on the lamp by pressing “Power/Standby” button on the control panel. **1**  
The startup screen will display for 30 seconds and the Power LED will flash **green**.  
When the startup screen disappears, the Power LED will turn **green**.
4. Turn on your source (computer, notebook, video player ,etc.).  
The projector will detect your source automatically.

❖ *If you connect multiple sources at the same time, use the “Source” button on the control panel to switch.*



❖ Turn on the projector first and then the signal sources.



# Installation

## Powering Off the Projector

1. Press the “Power/Standby” button to turn off the projector lamp, you will see a message “**Wait 2 minutes before you can switch on again**” on the on-screen display.
2. Press the “Power/Standby” button again to confirm. Otherwise the message will disappear after **10** seconds.
3. The cooling fans continue to operate for about 120 seconds for cooling cycle and the Power LED will turn red. When the light **stops** flashing, the projector has entered standby mode.  
If you wish to turn the projector back on, you must wait until the projector has completed the cooling cycle and has entered standby mode. Once in standby mode, simply press “Power/Standby” button to restart the projector.
4. Disconnect the power cord from the electrical outlet and the projector.
5. Do not turn on the projector immediately following a power off procedure.

## Warning Indicator

- ❖ *When the “TEMP” indicator turns red, it indicates the projector has overheated. The projector will automatically shut itself down. See page 31.*
- ❖ *When the “LAMP” indicator flashes **red (0.5 second intervals)**, it indicates a problem with the lamp. Turn off the projector and disconnect the power cord from the electrical outlet, then contact your local dealer or our service center. See page 31.*
- ❖ *When the “LAMP” indicator flashes **red (1 second intervals)**, it indicates **the fan failed**. Stop using the projector and disconnect the power cord from the electrical outlet, then contact your local dealer or our service center. See page 31.*

## Adjusting the Projected Image

### Adjusting the Projector Image Height

*The projector is equipped with an elevator foot for adjusting the image height.*

To raise the image:

1. Press the elevator button **1**.
2. Raise the image to the desired height angle **2**, then release the button to lock the elevator foot into position.
3. Use **3** to fine-tune the display angle.

To lower the image:

1. Press the elevator button.
2. Lower the image, then release the button to lock the elevator foot into position.
3. Use **3** to fine-tune the display angle.

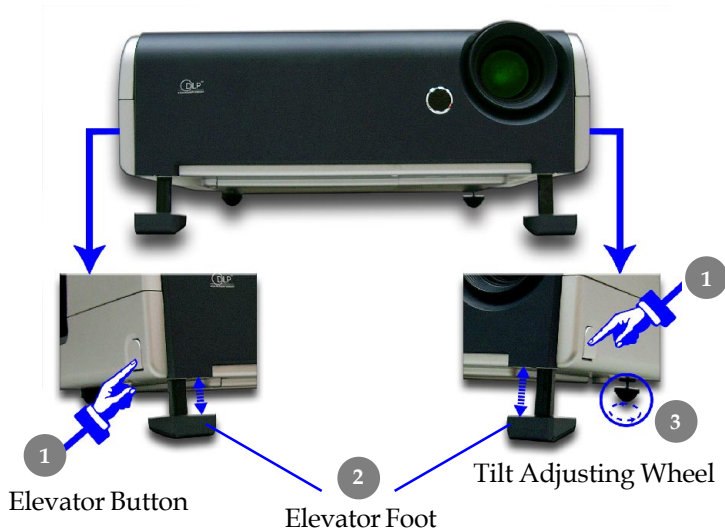

# Installation

## Adjusting the Projector Zoom/Focus

You may turn the zoom ring to zoom in or out. To focus the image, rotate the focus ring until the image is clear. The projector will focus at image diagonal size from 29.5" to 300" (0.75 to 7.62 M).

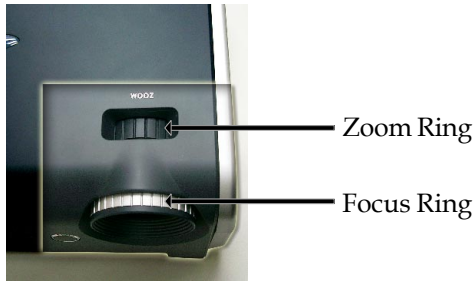

## Adjusting Projection Image Size

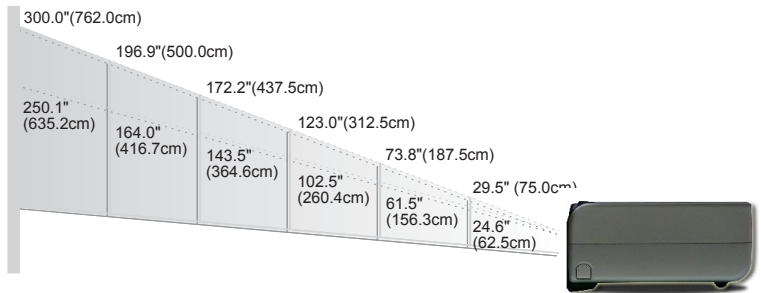

						3.94'(1.2m)	
						9.84'(3.0m)	
						16.40'(5.0m)	
						22.97'(7.0m)	
						26.25'(8.0m)	
						40.00'(12.2m)	
Screen (Diagonal)	Max.	29.5"(75.0cm)	73.8"(187.5cm)	123.0"(312.5cm)	172.2"(437.5cm)	196.9"(500.0cm)	300.0"(762.0cm)
	Min.	24.6"(62.5cm)	61.5"(156.3cm)	102.5"(260.4cm)	143.5"(364.6cm)	164.0"(416.7cm)	250.1"(635.2cm)
Screen Size	Max.(WxH)	23.60" x 17.70" (60.0 x 45.0cm)	59.04" x 44.28" (150.0 x 112.5cm)	98.40" x 73.80" (250.0 x 187.5cm)	137.76" x 103.32" (350.0 x 262.5cm)	157.52" x 118.14" (400.0 x 300.0cm)	240.00" x 180.00" (609.6 x 457.2cm)
	Min.(WxH)	19.68" x 14.76" (50.0 x 37.5cm)	49.20" x 36.90" (125.0 x 93.8cm)	82.00" x 61.50" (208.3 x 156.2cm)	114.80" x 86.10" (291.7 x 218.8cm)	131.20" x 98.40" (333.4 x 250.0cm)	200.00" x 150.00" (508.2 x 381.1cm)
Distance		3.94'(1.2m)	9.84'(3.0m)	16.40'(5.0m)	22.97'(7.0m)	26.25'(8.0m)	40.00'(12.2m)

❖ This graph is for user's reference only.

# User Controls

## Control Panel & Remote Control

There are two ways for you to control the functions: Remote Control and Control Panel.

### Control Panel



### Remote Control



### Using the Control Panel

#### Power/Standby

- ▶ Refer to the “Power On/Off the Projector” section on pages 11-12.

#### Source

- ▶ Press “Source” to choose RGB, Component-p, Component-i, S-Video, Composite Video and HDTV sources.





#### Menu

- ▶ Press “Menu” to launch the on screen display (OSD) menu. To exit OSD, press “Menu” again.

#### Keystone

- ▶ Adjusts image distortion caused by tilting the projector ( $\pm 16$  degrees).

#### Four Directional Select Keys

- ▶ Use     to select items or make adjustments to your selection.

#### Enter

- ▶ Confirm your selection of items.

#### Re-Sync (Only Analog RGB signal valid)

- ▶ Automatically synchronizes the projector to the input source.

# User Controls

## Using the Remote Control

### Power

- ▶ Refer to the “Power On/Off the Projector” section on pages 11-12.

### Sync

- ▶ Automatically synchronizes the projector to the input source.

### Keystone

- ▶ Adjusts image distortion caused by tilting the projector ( $\pm 16$  degrees).

### Display Format

- ▶ Display the “Display Format” section of the onscreen display menu to select the desired aspect ratio.

### Laser Button

- ▶ Aim the remote at the viewing screen, press and hold this button to activate the laser pointer.

### A/V Mute

- ▶ Momentarily turns off the audio and video.

### Freeze

- ▶ Press “Freeze” to pause the screen image.

### Display Mode

- ▶ Select the display mode from PC, Movie, Game, sRGB, Dynamic and User.

### Mouse/Mouse Right Click/Mouse Left Click (\*)

- ▶ These functions are the same as a mouse of PC or Mac.

### Page Up (\*)

- ▶ Use this button to page up.



### Page Down (\*)

- ▶ Use this button to page down.





### Page Scrolling (\*)

- ▶ Control the scroll bar to move the screen up or down.

### Zoom In /Zoom Out

- ▶ Press  or  button to zoom the lens in or zoom out.

### Four Directional Select Keys

- ▶ Use     to select items or make adjustments to your selection.



❖ **Remark : “\*”** this is computer mode only. And these functions are only available when the projector is connected to a computer via an USB cable.



# User Controls

## OK

- ▶ Confirm your selection of items.

## Source Lock

- ▶ Select auto detection all connector ports or lock current connector port.

## Menu

- ▶ Press "Menu" to launch the on screen display menu. To exit OSD, press "Menu" again.

## VGA

- ▶ Press "VGA" to change source to VGA-In connector. This connector supports Analog RGB, YPbPr (480p/576p/720p/1080i), YCbCr (480i/576i) and RGBsync.

## DVI-I

- ▶ Press "DVI-I" to change source to DVI-I connector. This connector supports Digital RGB, Analog RGB, YPbPr (480p/576p/720p/1080i), YCbCr (480i/576i) and HDCP signal.

## Component

- ▶ Press "Component" to change source to component connector. This connector supports YPbPr (480p/576p/720p/1080i) and YCbCr (480i/576i).

## S-Video

- ▶ Press "S-Video" to change source to S-Video source.











## Video

- ▶ Press "Video" to change source to Composite Video source.

## On Screen Display Menus

The Projector has multilingual On Screen Display menus that allow you to make image adjustments and change a variety of settings. The projector will automatically detect the source.

### How to operate

1. To open the OSD menu, press “Menu ” on the Remote Control or Control Panel.
2. When OSD is displayed, use   keys to select any item in the main menu. While making a selection on a particular page, press  key to enter sub menu.
3. Use   keys to select the desired item and adjust the settings by   key.
4. Select the next item to be adjusted in the sub menu and adjust as described above.
5. Press “Menu ” to confirm, and the screen will return to the main menu.
6. To exit, press “Menu ” again. If you don’t press any key, the projector will automatically disappear after 30 seconds. The OSD menu will close and the projector will automatically save the new settings.

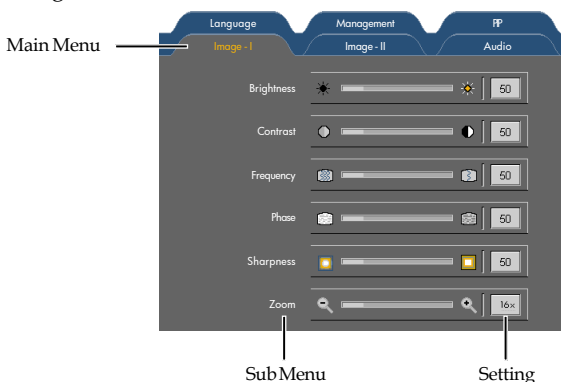



## Computer / Video Mode



## Language

### Language

Choose the multilingual OSD menu . Use the  or  key to select your preferred language.

Press "Menu" to finalize the selection.

# User Controls

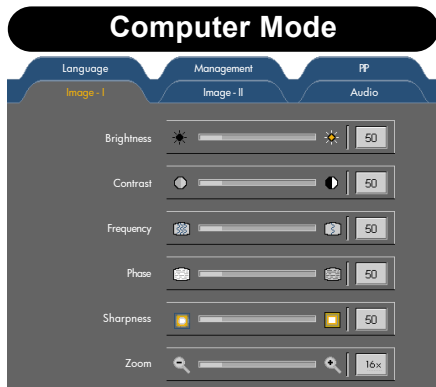

## Image-I (Computer Mode)

### Brightness

Adjust the brightness of the image.

- ▶ Press the ◀ to darken image.
- ▶ Press the ▶ to lighten the image.

### Contrast

The contrast controls the degree of difference between the lightest and darkest parts of the picture. Adjusting the contrast changes the amount of black and white in the image.

- ▶ Press the ◀ to decrease the contrast.
- ▶ Press the ▶ to increase the contrast.

### Frequency

“Frequency” changes the display data frequency to match the frequency of your computer’s graphic card. If you experience a vertical flickering bar, use this function to make an adjustment.

### Phase

“Phase” synchronizes the signal timing of the display with the graphic card. If you experience an unstable or flickering image, use this function to correct it.

### Sharpness

Adjusts the sharpness of the image.

- ▶ Press the ◀ to decrease the sharpness.
- ▶ Press the ▶ to increase the sharpness.

### Zoom

- ▶ Press the ▶ to magnify an image up to a factor of **16** times on the projection screen.
- ▶ Press the ◀ to diminish the zoom in image.



❖ “Sharpness” function is not supported under computer mode.

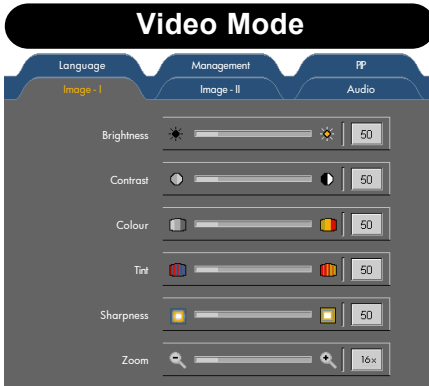

## Image-I (Video Mode)

### Brightness

Adjust the brightness of the image.

- ▶ Press the ◀ to darken image.
- ▶ Press the ▶ to lighten the image.

### Contrast

The contrast controls the degree of difference between the lightest and darkest parts of the picture. Adjusting the contrast changes the amount of black and white in the image.

- ▶ Press the ◀ to decrease the contrast.
- ▶ Press the ▶ to increase the contrast.

### Colour (saturation)

Adjusts a video image from black and white to fully saturated color.

- ▶ Press the ◀ to decrease the amount of color in the image.
- ▶ Press the ▶ to increase the amount of color in the image.

### Tint

Adjusts the color balance of red and green.

- ▶ Press the ◀ to increase the amount of green in the image.
- ▶ Press the ▶ to increase the amount of red in the image.

### Sharpness

Adjusts the sharpness of the image.

- ▶ Press the ◀ to decrease the sharpness.
- ▶ Press the ▶ to increase the sharpness.

### Zoom

- ▶ Press the ▶ to magnify an image up to a factor of 16 times on the projection screen.
- ▶ Press the ◀ to diminish the zoom in image.



❖ "Colour" function is not supported under YPbPr source.

❖ "Sharpness" function is not supported under YPbPr and YCbCr source.

# User Controls

## Computer/Video Mode

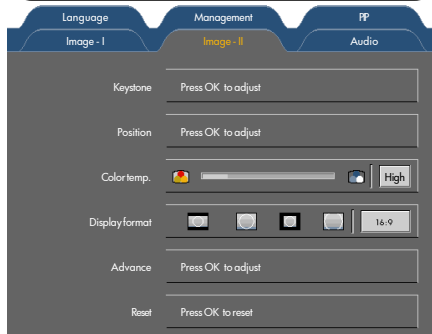

## Image-II

### Keystone (Keystone Correction)

Adjust image distortion caused by tilting projection. ( $\pm 16$  degrees)

Press OK to adjust



- ▶ Vertical keystone: Press the ◀ or ▶ to adjust image distortion vertically and makes a squarer image.
- ▶ Horizontal keystone: Press the ◀ or ▶ to adjust image distortion horizontally and makes a squarer image.

### Position

Adjust the image position. Press OK to adjust



- ▶ Vertical Position  
Press the ◀ to move the image down.  
Press the ▶ to move the image up.
- ▶ Horizontal Position  
Press the ◀ to move the image left.  
Press the ▶ to move the image right.

### Color Temp.

Adjust the color temperature. At higher temperature, the screen looks colder; at lower temperature, the screen looks warmer.

### Display Format





Use this function to choose your desired aspect ratio.

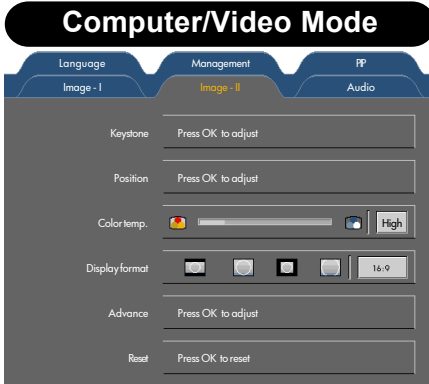

❖ "Position" function is not supported under DVI-I source.



## Image-II

- ▶  Windows : The input source will be compacted in the center with scaling.
- ▶  4:3 : The input source will be scaled to fit the projection screen.
- ▶  16:9 : The input source will be scaled to fit the width of the screen.
- ▶  Letterbox: Letterbox mode zooms a letterboxed image intended for 4:3 display to full screen wide.



Original Input

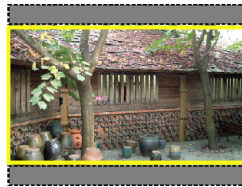

The letterbox

### Advance

Press OK to adjust the R (Red), G (Green), or B (Blue) for brightness and contrast.

### Reset

Press OK to return the display parameters on all menus to their factory default settings.

# User Controls

## Computer/Video Mode



## Audio

### Volume

- ▶ Press the ◀ to decrease the volume.
- ▶ Press the ▶ to increase the volume.

### Treble

The treble setting controls the higher frequencies of your audio source.



- ▶ Press the ◀ to decrease the treble.
- ▶ Press the ▶ to increase the treble.

### Bass

The Bass setting controls the lower frequencies of your audio source.

- ▶ Press the ◀ to decrease the bass.
- ▶ Press the ▶ to increase the bass.

### Stereo / Mono

- ▶ Mono : Mono sound effect.
- ▶ Stereo : Stereo sound effect.

### Mute

- ▶ Choose the left icon to turn mute on.
- ▶ Choose the right icon to turn mute off.



## Computer/Video Mode

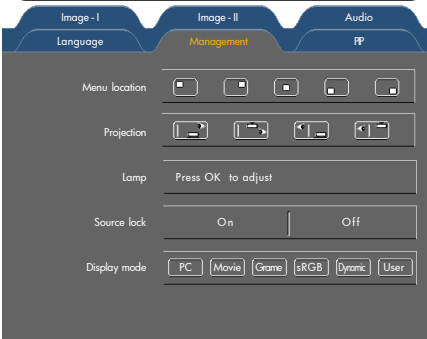

## Management

### Menu Location

Choose the menu location on the display screen.

### Projection

▶  **Front-Desktop**

The factory default setting.

▶  **Rear-Desktop**

When you select this function, the projector reverses the image so you can project behind a translucent screen.

▶  **Front-Ceiling**

When you select this function, the projector turns the image upside down for ceiling-mounted projection.

▶  **Rear-Ceiling**

When you select this function, the projector reverses and turns the image upside down at same time. You can project from behind a translucent screen with ceiling mounted projection.

### Lamp

Press OK to adjust.

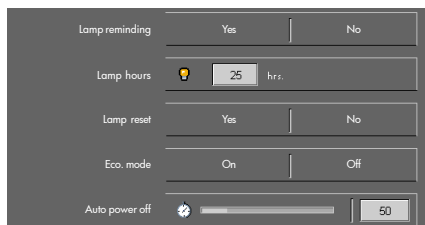

# User Controls

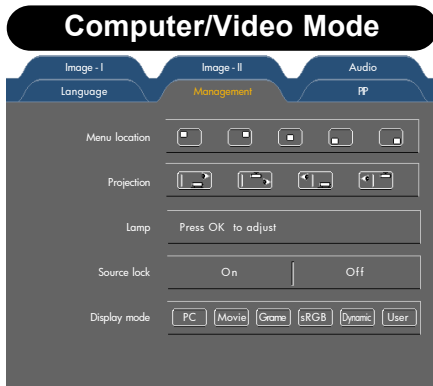

## Management

- ▶ **Lamp Reminding:** Select this function to show or hide the warning message when the lamp replacing reminder message is displayed. The message will show up when the lamp reaches 1500 hours at normal mode. See “Replacing the Lamp” for more details.
- ▶ **Lamp Hours:** Display the cumulative lamp operating time.
- ▶ **Lamp Reset:** Reset the lamp life hour after replacing a new lamp.
- ▶ **ECO Mode:** Choose “On” to dim the projector lamp which will lower power consumption and extend the lamp life by up to 130%. Choose “Off” to return normal mode.
- ▶ **Auto Power Off :** Set the interval of power off the system if there is no signal input. (In minutes)

### Source Lock

When source lock is turned off, the projector will search for other signals if the current input signal is lost. When source lock is turned on, it will search specified connection port.

### Display Mode

There are many factory presets optimized for various types of images.

- ▶ **PC :** For computer or notebook.
- ▶ **Movie :** For home theater.
- ▶ **Game :** For game.
- ▶ **sRGB :** For PC standard color.
- ▶ **Dynamic :** For all these four modes as above and get more contrast and color saturation.
- ▶ **User :** Memorize user’s settings.

## Computer/Video Mode

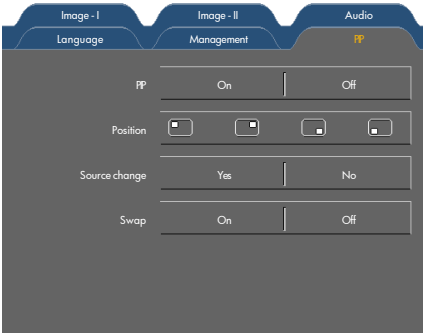

## *PIP*

### **PIP**

Choose "On" to select on the PIP screen.

### **Position**

Choose the PIP screen position on the display screen.

### **Source Change**

Choose the input source of the projector on the PIP screen.

### **Swap**

Choose "On" to swap main screen and PIP screen each other.

## Troubleshooting

*If you experience trouble with the projector, refer to the following information. If the problem persists, please contact your local reseller or service center.*

### **Problem: No image appears on screen.**

- ▶ Ensure all the cables and power connections are correctly and securely connected as described in the "Installation" section.
- ▶ Ensure the pins of connectors are not crooked or broken.
- ▶ Check if the projection lamp has been securely installed. Please refer to the "Replacing the lamp" section.
- ▶ Make sure you have removed the lens cap and the projector is switched on.
- ▶ Press A/V Mute button to make sure the image has not been turned off temporarily.

### **Problem: Partial, scrolling or incorrectly displayed image.**

- ▶ Press the "Sync" button on the Remote Control or Press the "Re-Sync" button on the Control Panel.
- ▶ If you use a PC:

If the resolution of your computer is higher than 1024 x 768. Follow the steps outlined below to reset the resolution.

For Windows 3.x:

1. In the Windows Program Manager, click the "Windows Setup" icon in the Main group.
2. Verify that your display resolution setting is less than or equal to 1024 x 768.

For Windows 95,98,2000,XP:

1. Open "My Computer" icon, the "Control Panel" folder, and then double click on the "Display" icon.
2. Select the "Setting" tab.
3. In the "Desktop Area" you will find the resolution setting. Verify that the resolution setting is less than or equal to 1024 x 768 resolution.

**If the projector is still not projecting the whole image, you will also need to change the monitor display you are using. Refer to the following steps.**

# Appendices

4. Follow the above steps 1-2. Click on the “Advanced Properties” button.
  5. Select the “Change” button under the “Monitor” tab .
  6. Click on “Show all devices” . Then select “Standard monitor types” under the “Manufacturers” box ; choose the resolution mode you need under the “Models” box.
  7. Verify that the resolution setting of the monitor display is less than or equal to 1024 x 768.
- ▶ If you are using a Notebook PC:
    1. You are required to implement the above steps of resolution setting of the computer first.
    2. Switch the Notebook PC display to the “external display only” or “CRT only” mode.
  - ▶ If you experience difficulty in changing resolutions or your monitor freezes, restart all the equipment and the projector.

## **Problem: The screen of the Notebook or PowerBook computer is not displaying your presentation.**

- ▶ If you are using a Notebook PC:

Some Notebook PCs may deactivate their screens when a second display device is in use. Refer to your computer’s documentation for information on how to reactivate the monitor display.
- ▶ If you are using an Apple PowerBook:

In Control Panels, open the PowerBook Display to select Video Mirroring “On” .

## **Problem: Image is unstable or flickering**

- ▶ Use “Phase” to correct it. Refer to page 20.
- ▶ Change the monitor color setting from your computer.

## **Problem: Image has vertical flickering bar**

- ▶ Use “Frequency” to make an adjustment. Refer to page 20.
- ▶ Check and reconfigure the display mode of your graphic card to make it compatible with the product. Refer to page 28.

## **Problem: Image is out of focus**

- ▶ Adjusts the Focus Ring on the projector lens. Refer to page 14.
- ▶ Make sure the projection screen is between the required distance 3.9 to 32.8 feet (1.2 to 10.0 meters) from the projector.

# Appendices

## **Problem: The image is outstretched when displaying 16:9 DVD.**

The projector automatically detects 16:9 DVD and adjusts the aspect ratio by digitizing to full screen with 4:3 default setting.

If the image is still outstretched, you will also need to adjust the aspect ratio by referring to the following:

- ▶ Please select 4:3 aspect ratio type on your DVD player if you are playing a 16:9 DVD.
- ▶ If you can't select 4:3 aspect ratio type on your DVD player, please select 4:3 aspect ratio in the on screen menu.

## **Problem: Image is reversed.**

- ▶ Select "Management" from the OSD and adjust the projection direction. See page 25.

## **Problem: Lamp burns out or makes a popping sound**

- ▶ When the lamp reaches its end of life, it will burn out and may make a loud popping sound. If this happens, the projector will not turn on until the lamp module has been replaced. To replace the lamp, follow the procedures in the "Replacing the Lamp". See page 32.

## **Problem: LED lighting message**

Message	Power LED		Temp LED	Lamp LED
	Green	Red		
Standby State	○	☀	○	○
Warming	Flashing	○	○	○
Cooling	○	Flashing	○	○
Normal	☀	○	○	○
Error (Lamp failed)	○	○	○	Flashing
Error (Fan failed)	○	○	○	Flashing
Error (Over Temp.)	○	○	☀	○

## Problem: Message Reminders

▶ Standby :

Wait 2 minutes before you can switch on again  
Press Power key again to confirm  
Press OK key to move this warning

▶ Over Temperature :

The projector will switch off automatically.  
Please:  
1 Allow cool down for 3 minutes  
2 Make sure air in and outlets are noblocked  
3 Clean the dust filter  
If the problem persists in spite of the adove,  
please contact a service centre for repair.

▶ Fan Failed :

The projector will switch off automatically.  
please contact a service centre for repair.

▶ Replacing the lamp :

Lamp life exceed

# Appendices

## Replacing the lamp

The projector will detect the lamp life itself. It will show you a warning message "Lamp life exceed" When you see this message, change the lamp as soon as possible.

Make sure the projector has been cooled down for at least 30 minutes before changing the lamp.



**Warning:** Lamp compartment is hot! Allow it to cool down before changing lamp!

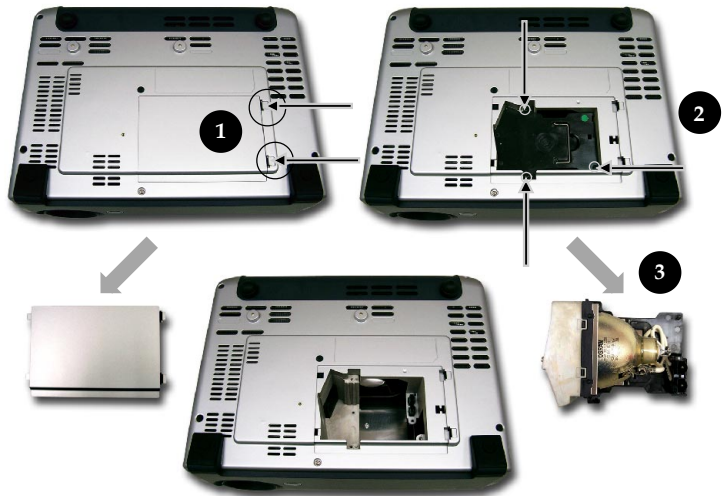

**Warning:** To reduce the risk of personal injury, do not drop the lamp module or touch the lamp bulb. The bulb may shatter and cause injury if it is dropped.

### Lamp Changing Procedure:

1. Turn off the power to the projector by pressing the Power button.
2. Allow the projector to cool down at least 30 minutes.
3. Disconnect the power cord.
4. Push up and Remove the cover. ①
5. Remove the 3 screws from the lamp module. ②
6. Pull out the lamp module. ③

To replace the lamp module, reverse the previous steps.



# Appendices

## Compatibility Modes

Mode	Resolution	(ANALOG)		(DIGITAL)	
		V.Frequency (Hz)	H.Frequency (kHz)	V.Frequency (Hz)	H.Frequency (kHz)
VESA VGA	640 x 350	70	31.5	70	31.5
VESA VGA	640 x 350	85	37.9	85	37.9
VESA VGA	640 x 400	85	37.9	85	37.9
VESA VGA	640 x 480	60	31.5	60	31.5
VESA VGA	640 x 480	72	37.9	72	37.9
VESA VGA	640 x 480	75	37.5	75	37.5
VESA VGA	640 x 480	85	43.3	85	43.3
VESA VGA	720 x 400	70	31.5	70	31.5
VESA VGA	720 x 400	85	37.9	85	37.9
SVGA	800 x 600	56	35.2	56	35.2
SVGA	800 x 600	60	37.9	60	37.9
SVGA	800 x 600	72	48.1	72	48.1
SVGA	800 x 600	75	46.9	75	46.9
SVGA	800 x 600	85	53.7	85	53.7
VESA XGA	1024 x 768	43.4	35.5	44.9	35.5
VESA XGA	1024 x 768	60	48.4	60	48.4
VESA XGA	1024 x 768	70	56.5	70	56.5
VESA XGA	1024 x 768	75	60.0	75	60.0
VESA XGA	1024 x 768	85	68.7	85	68.7
* VESA SXGA	1152 x 864	70	63.8	70	63.8
* VESA SXGA	1152 x 864	75	67.5	75	67.5
* VESA SXGA	1152 x 864	85	77.1	85	77.1
* VESA SXGA	1280 x 1024	60	63.98	60	63.98
* VESA SXGA	1280 x 1024	75	79.98	75	79.98
* VESA SXGA	1280 x 1024	85	91.1	85	91.1
* VESA SXGA+	1400 x 1500	60	63.98	60	63.98
* VESA UXGA	1600 x 1200	60	75	60	75
MAC LC 13"	640 x 480	66.66	34.98	-	-
MAC II 13"	640 x 480	66.68	35	-	-
MAC 16"	832 x 624	74.55	49.725	-	-
MAC 19"	1024 x 768	75	60.24	-	-
* MAC	1152 x 870	75.06	68.68	-	-
MAC G4	640 x 480	60	31.35	-	-
MAC G4	640 x 480	120	68.03	-	-
MAC G4	1024 x 768	120	97.09	-	-
i Mac DV	640 x 480	117	60	-	-
i Mac DV	800 x 600	95	60	-	-
i Mac DV	1024 x 768	75	60	-	-
* i Mac DV	1152 x 870	75	68.49	-	-
* i Mac DV	1280 x 960	75	75	-	-
* i Mac DV	1280 x 1024	85	91.1	-	-



**Remark :** " \* " compressed computer image.

## Ceiling Mount Installation

1. To prevent damaging your projector, please use the ceiling mount package for installation.
2. If you wish to use a third party ceiling mount kit please ensure the screws used to attached a mount to the projector met the following specifications:

- ▶ **Screw type: M3**
- ▶ **Maximum screw length: 6mm**



❖ Please note that damage resulting from incorrect installation will invalidate the warranty.

